

NEW FORMAT

MERS, DINING TABLE

MATERIALS

Top: Domestic Hardwood

Base: Aluminum

SIZE

60" D x 30" H

* Custom sizing available, please inquire

DESCRIPTION

The Mers Side Table is fabricated from solid aluminum and can be patinated with our in-house salt pack technique, or powdercoated in an array of colors. Suitable for use indoors and out. Form is inspired by the simple utilitarianism of West Coast aluminum fishing boats.

SHOWN

(Right) Black Powdercoated base and Walnut top

(below left) Satin Aluminum base and top

(below right) Black Powdercoated base and top

* Available in other options, please inquire

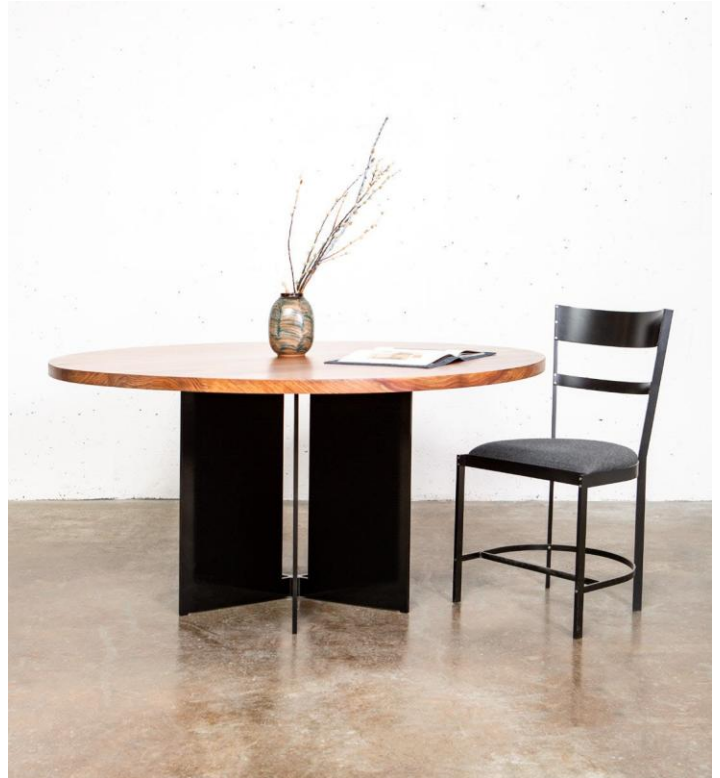

NEW FORMAT

MERS, COLLECTION

* Custom dimensions available, please inquire

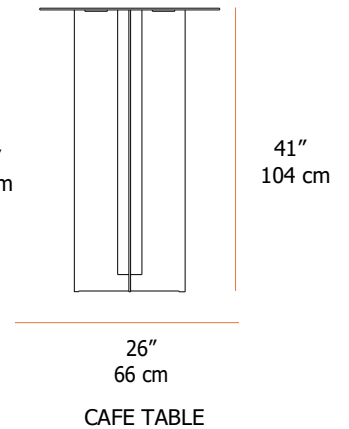
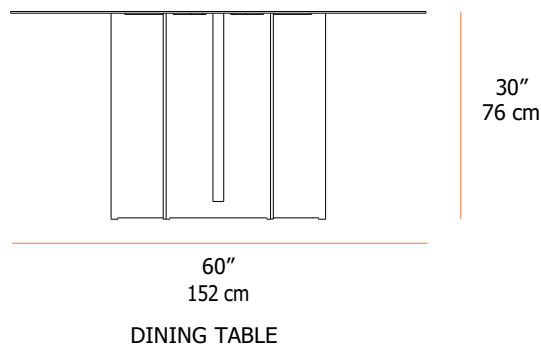
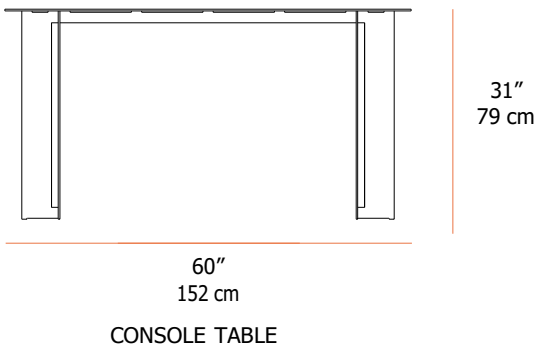
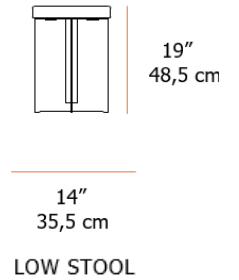
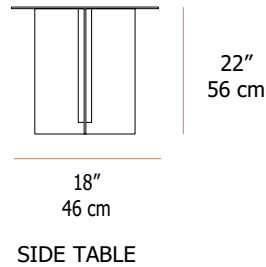
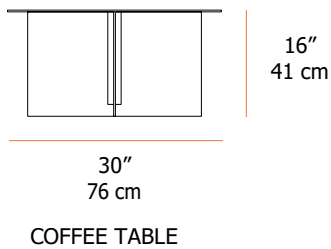

MATERIALS AND FINISHES

* Custom options available, please inquire

STANDARD FINISHES (Base Price)

ALTERNATIVE FINISHES (Price will be adjusted)

Top

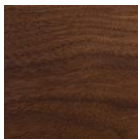

Black Walnut

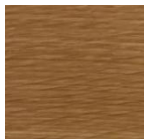

Oak

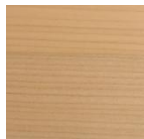

Western Maple

Base

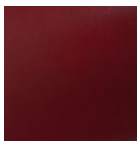

Burgundy
Powdercoat

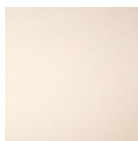

Cream
Powdercoat

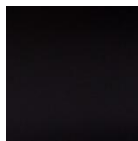

Black
Powdercoat



Pacific Blue
Powdercoat

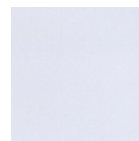

White
Powdercoat



Ochre
Powdercoat

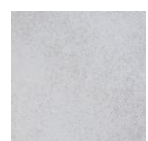

Aluminum
Salt Pack